

## VKM CENTRIFUGAL SERIES

### • Application

The Fanco VKM series are designed for supply and exhaust ventilation of premises requiring high pressure and powerful airflow. The fans are compatible with round duct with models from 100mm to 315mm. The fan casing is made of steel with polymeric coating

### • About the motor

All motors are equipped with a single phase motor. All motors have thermal overheating protection, ball bearings which ensure a motor life expectancy of 40,000 hours at non stop operation. The motor is IPX4 rated.

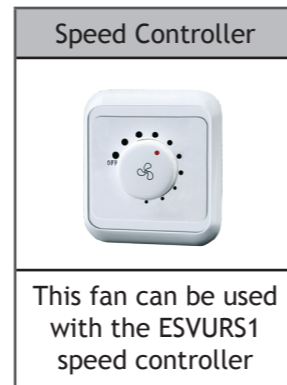

SKU	Description
EXVUV100	VKM 100mm Centrifugal Inline Fan
EXVUV125	VKM 125mm Centrifugal Inline Fan
EXVUV150	VKM 150mm Centrifugal Inline Fan
EXVUV200	VKM 200mm Centrifugal Inline Fan
EXVUV250	VKM 250mm Centrifugal Inline Fan
EXVUV315	VKM 315mm Centrifugal Inline Fan

### Fan Overall Dimensions (mm)

SKU	D	D1	B	B1	L	L1	L2	L3
EXVUV100	98	254	298	258	205	20	25	30
EXVUV125	123	254	298	258	205	20	25	30
EXVUV150	149	304	349	309	220	25	25	30
EXVUV200	198	344	390	350	240	25	29	40
EXVUV250	248	344	390	350	249	25	31	40
EXVUV315	314	404	454	414	260	25	40	40

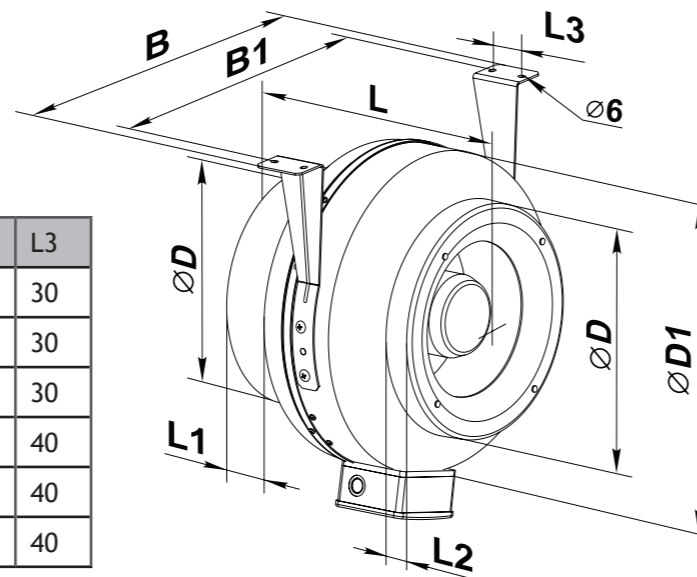

### EXVUV100 - VKM 100mm Centrifugal Inline Fan

Voltage	220 - 240
Power (W)	73
Current (A)	0.32
Capacity (m3/hr)	270
Capacity (l/s)	75.06
Capacity (CFM)	159.03
RPM (min-1)	2830
Noise Level at 3m (dBA)	47
Max air temp (°C)	55
Protection rating	IPX4

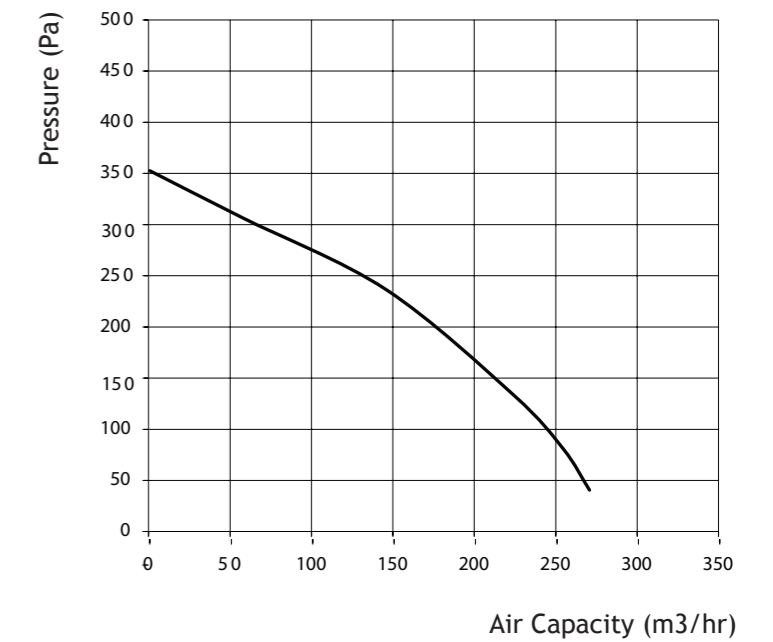

### EXVUV125 - VKM 125mm Centrifugal Inline Fan

Voltage	220 - 240
Power (W)	75
Current (A)	0.33
Capacity (m3/hr)	355
Capacity (l/s)	98.69
Capacity (CFM)	209.09
RPM (min-1)	2800
Noise Level at 3m (dBA)	47
Max air temp (°C)	55
Protection rating	IPX4

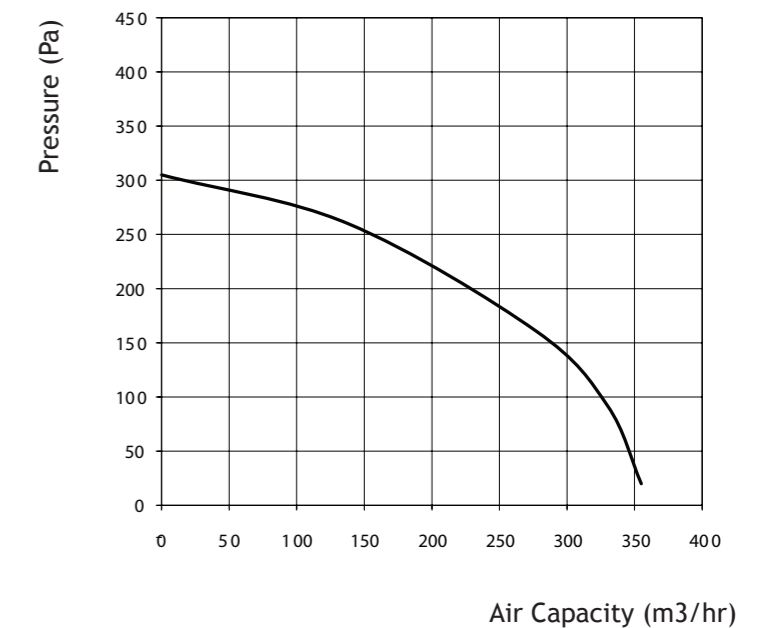

## VKM CENTRIFUGAL SERIES

### EXVUV150 - VKM 150mm Centrifugal Inline Fan

Voltage	220 - 240
Power (W)	98
Current (A)	0.43
Capacity (m3/hr)	555
Capacity (l/s)	154.29
Capacity (CFM)	326.89
RPM (min-1)	2705
Noise Level at 3m (dBA)	47
Max air temp (°C)	55
Protection rating	IPX4

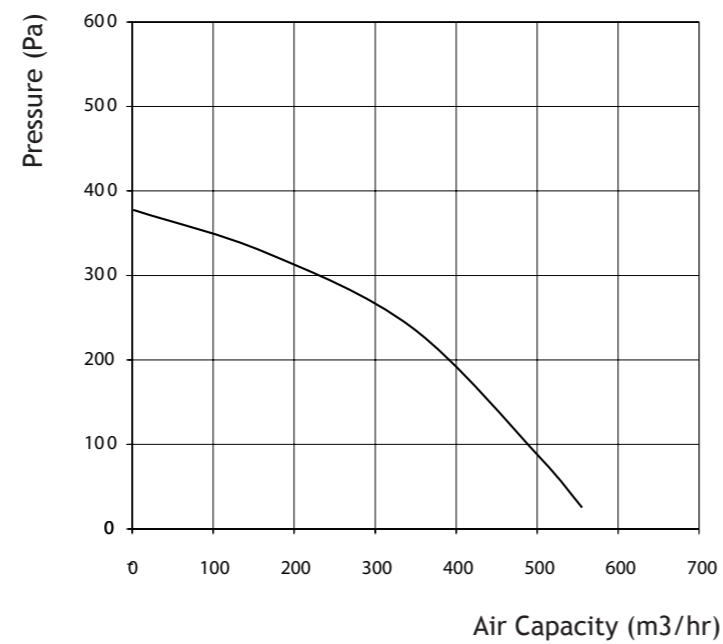

### EXVUV250 - VKM 250mm Centrifugal Inline Fan

Voltage	220 - 240
Power (W)	194
Current (A)	0.85
Capacity (m3/hr)	1310
Capacity (l/s)	364.18
Capacity (CFM)	771.59
RPM (min-1)	2790
Noise Level at 3m (dBA)	52
Max air temp (°C)	50
Protection rating	IPX4

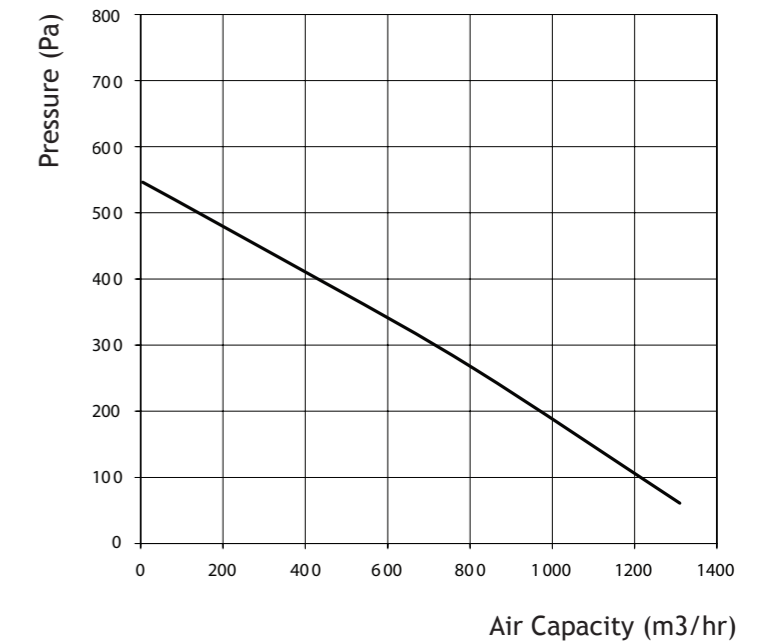

### EXVUV200 - VKM 200mm Centrifugal Inline Fan

Voltage	220 - 240
Power (W)	193
Current (A)	0.84
Capacity (m3/hr)	1100
Capacity (l/s)	305.8
Capacity (CFM)	647.9
RPM (min-1)	2780
Noise Level at 3m (dBA)	51
Max air temp (°C)	45
Protection rating	IPX4

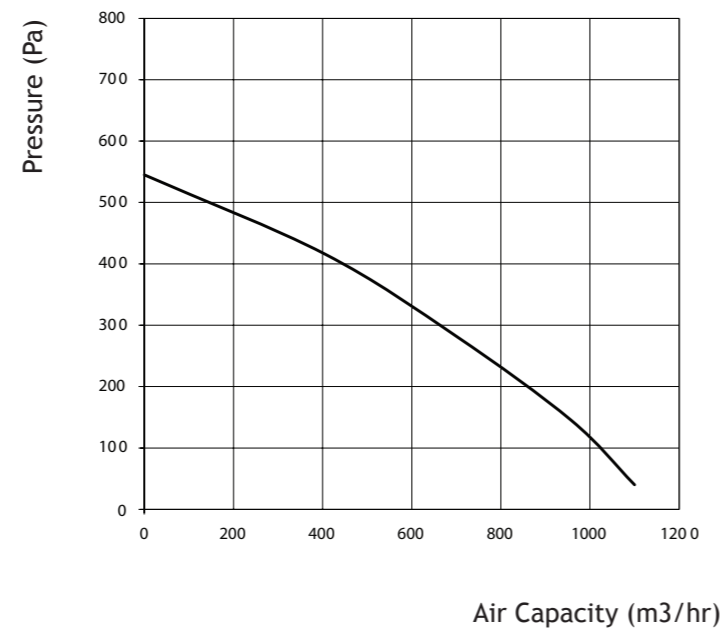

### EXVUV315 - VKM 315mm Centrifugal Inline Fan

Voltage	220 - 240
Power (W)	296
Current (A)	1.34
Capacity (m3/hr)	1880
Capacity (l/s)	522.64
Capacity (CFM)	1107.32
RPM (min-1)	2720
Noise Level at 3m (dBA)	54
Max air temp (°C)	45
Protection rating	IPX4

